

LS Series

Linear Bar Sill Diffusers and Grilles (Type 7)

MODEL: LS-T7

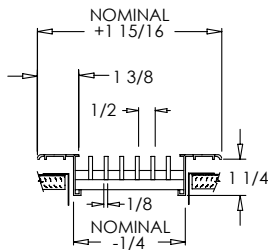
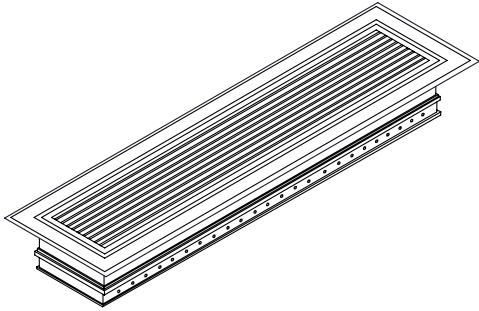

LS 1/2 0°
STANDARD FRAME

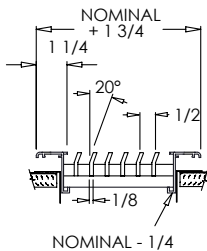

LS 1/2 20°
X FRAME

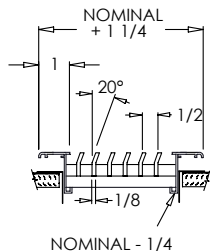

LS 1/2 20°
Y FRAME

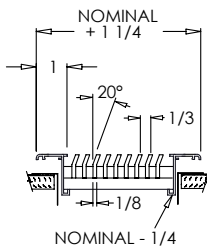

LS 1/3 20°
Y FRAME

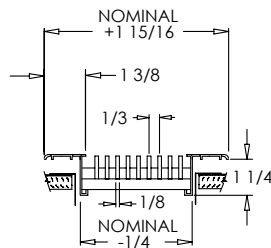

LS 1/3 0°
STANDARD FRAME

Standard Features:

- Precision aluminum construction for clean styling and efficient air distribution
- Extruded aluminum frame with signature line marks
- Standard frame with is 1 3/8"
- Reinforced with pressure lock honeycomb construction to withstand heavy foot traffic
- Available in lengths up to 144" in one piece (may vary for shipping and manufacturing considerations)
- Maximum available width is 14"
- 1/8" thick core blades run parallel to longest dimension
- 1/2" spacing with 0° or 20° deflection; actual spacing between bars is 3/8"
- 1/3" spacing with 0° or 20° deflection; actual spacing between bars is 1/4"
- Satin Anodized

Options:

- Recessed screwdriver-operated opposed blade damper – 1/2" spacing (OBD)
- Lever-operated opposed blade damper – 1/3" spacing (OBD)
- Extruded aluminum adjustable curved blade air deflection grid (Grid)
- Screwdriver-operated opposed blade damper with extruded aluminum adjustable curved blade air deflection grid (OBD-Grid)
- Gym Grade construction with welded support brackets and frame, and extra center margin supports (HD)
- Short Blades: core blades run parallel to shortest dimension
- Special Shapes: mitered and custom shapes diffusers (see website for more details)
- Butt joints for continuous lengths
- Fractional I.D. and O.D. sizes available

Blade Spacing Options:

- 1/2" - 0° Deflection
- 1/3" - 0° Deflection
- 1/2" - 20° Deflection
- 1/3" - 20° Deflection

Frame Widths:

- 1 3/8" Frame (standard)
- 1 1/4" Frame (option X)
- 1" Frame (option Y)

Finishes:

STANDARD COLORS

- Soft White
- Driftwood Tan
- Mill Finish
- Satin Anodized

DESIGNER COLORS

- Black
- Bronze
- Storm Gray
- Cement Gray

- Aluminum Paint
- Coffee Tan
- Warm White
- Glossy White

Continued next page.

OBD & Grid Options:

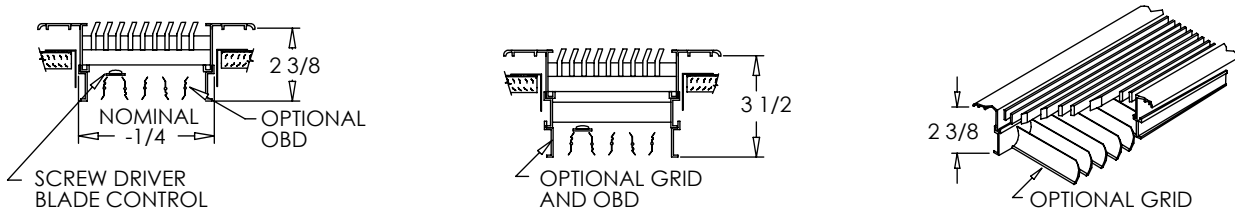

FRAME OPTIONS:

Standard Frame

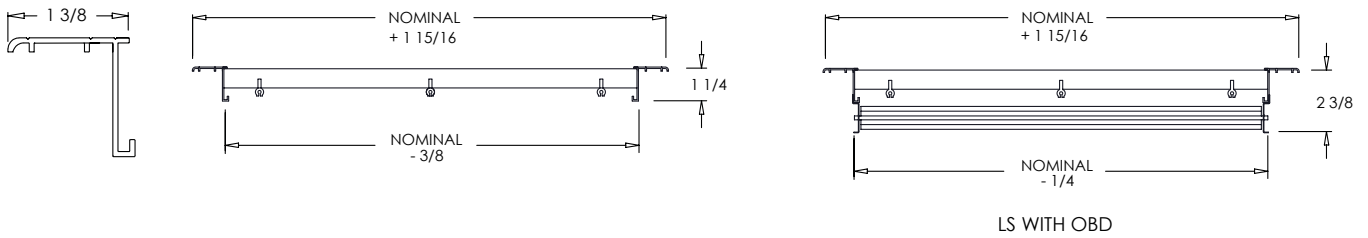

X Frame

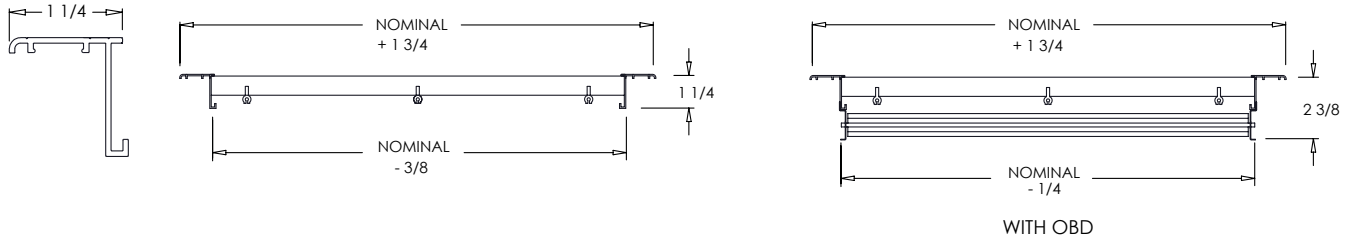

Y Frame

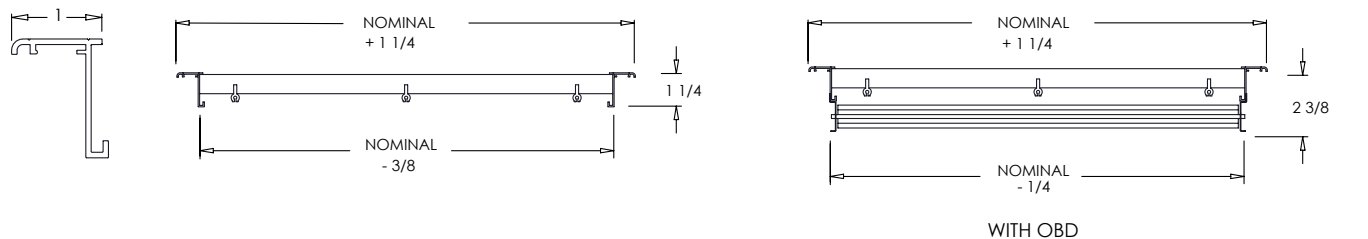

Additional Information:

Submittal Notes

Project / Location:	
Engineer:	
Architect:	
Contractor:	